

SAS - III

Sash Assembling Station

PRODUCT WEB LINK



FEATURES

Used to assembly all Tilt&Turn hardware systems on different types, various, sizes of window & door sash profiles without tape measure and pencil using, without need for molds and templates, provides speedy, high quality and standard assembling. Used to assembly all Tilt&Turn hardware systems on different types, various, sizes of window & door sash profiles. Adjustment make by revolver automatic system after selected on touch screen. Suitable for all kind of Tilt & Turn and accessories assembling

STANDARD EQUIPMENT

- Sash assembling table
- Automatic window sash centering system
- Automatic espagnolettes and scissors
- measuring system
- Espagnolettes and scissor cutting punch

OPTIONAL EQUIPMENT

- Full Automatic Screwing with two steps
- Double Automatic screw feeding unit
- Movable adjustable triple handle hole drilling group with air cooling
- Semi automatic adjustable, Hinge drilling and manual hinge screwing group
- Milling tool for espagnolette channel grooving and air unit
- Full automatic water slot drilling system with 4 motors
- Laser pointer



WEB

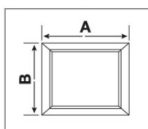
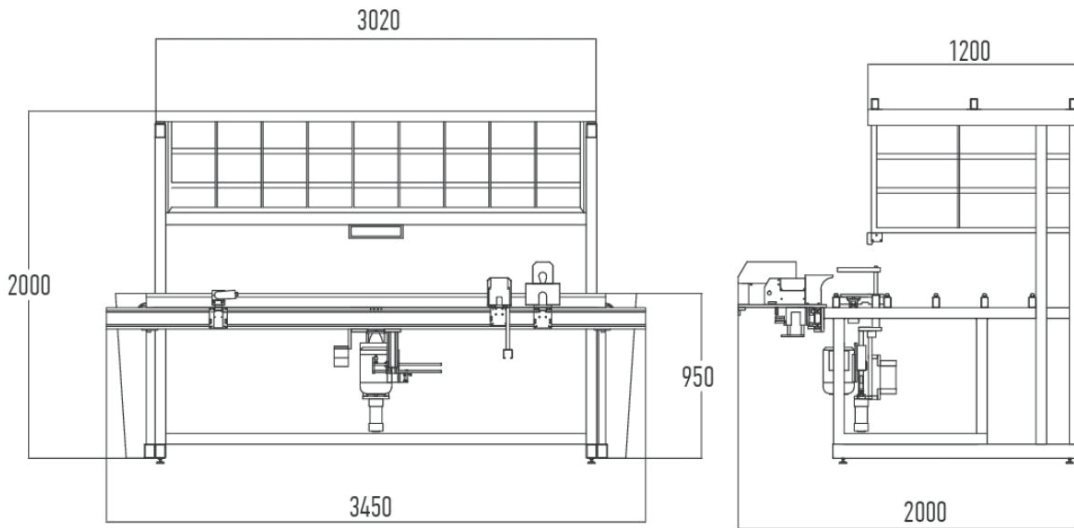

A Min : 330
A Max : 2520

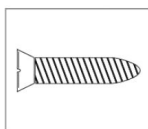

Min 3,9 x 16
Max 4,2 x 38

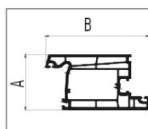

A min : 30 mm
A max : 100 mm
B min : 50 mm
B max : 125 mm



V : 380
kW : 3
A : 8

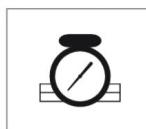

6-8 bar 250/lt/syc

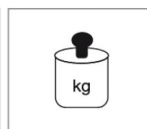

850 kg

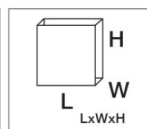

3450 x 2000 x 2020